

THE PROPERTY OF THIS DRAWING IS ESTABLISHED BY LAW
IT IS FORBIDDEN TO REPRODUCE IT OR SHOW IT TO THIRD PARTY
WITHOUT A WRITTEN AGREEMENT.

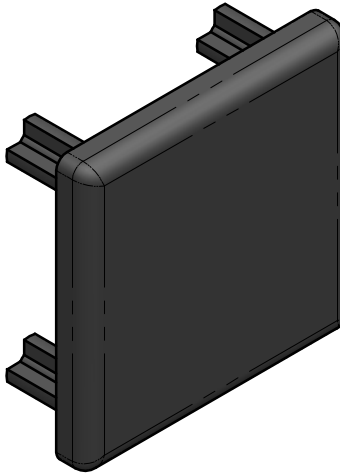
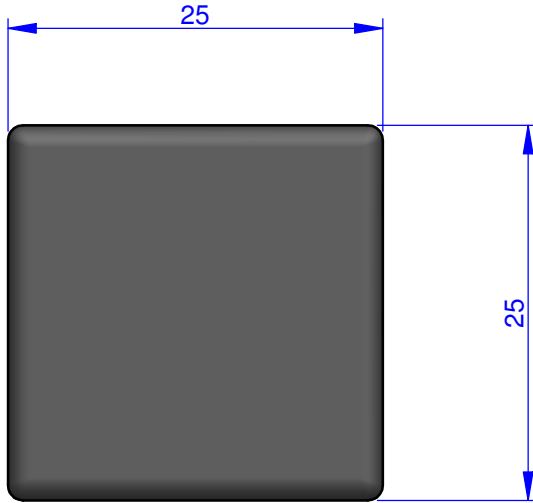

MODIFICATIONS: VARIED DIMENSIONS AS OF DATE:

7.	10.
8.	11.
9.	12.

MODIFICATIONS: VARIED DIMENSIONS AS OF DATE:

1.	4.
2.	5.
3.	6.

FP Services



DESIGNED FROM
FPSERVICES

DATE	11/2013	WEIGHT	0,002 kg
------	---------	--------	----------

CODE
CA.ADK.X.2525

Format **A4**
UNI 936-76

GENERAL TOLERANCE:
UNI - ISO 2768
CLASSE f

DESCRIPTION

